

REV NO.	DATE	REVISION	DR	CH	APP
△					

SPECIFICATION

- Rating : 150mA, DC 42V (Switching)
200mA, DC 42V (None-Switching)
- Contact Resistance : 80mΩ Max
- Insulation Resistance : 100MΩ Min at DC 250V
- Operating Force : 700gf Max
- Life cycle : 10,000 steps
- Sealing : IP67 (Dust & Water proof)
- Packing : 50pcs Tube

16 P o s i t i o n	Real Coded					
	C	1	2	4	8	
0	●				0	
1	●	●			1	
2	●		●		2	
3	●	●	●		3	
4	●			●	4	
5	●	●		●	5	
6	●		●	●	6	
7	●	●	●	●	7	
8	●				●	8
9	●	●			●	9
10	●		●		●	A
11	●	●	●		●	B
12	●			●	●	C
13	●	●		●	●	D
14	●		●	●	●	E
15	●	●	●	●	●	F

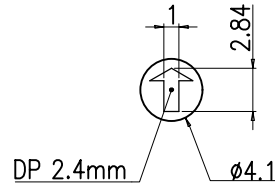

ACTUATOR

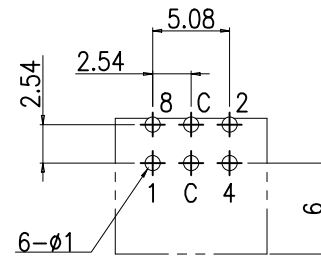
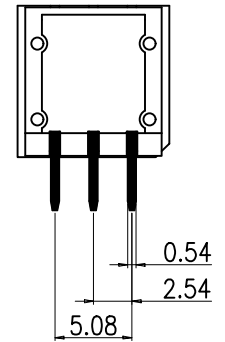
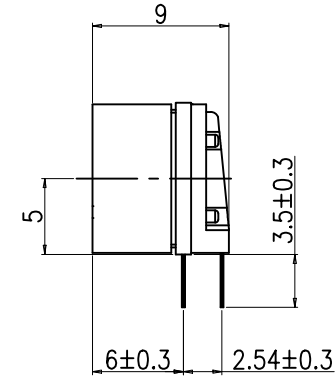
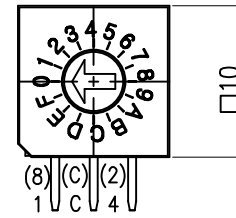

P.C.B DIMENSION (Top View)

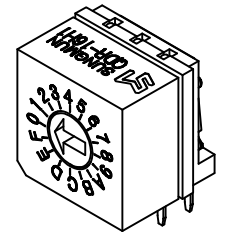
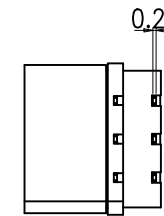

Din ISO-2768-1m					
Ranges	0.5~3	3~6	6~30	30~120	120~400
Tolerance	±0.1	±0.1	±0.2	±0.3	±0.5

DRAW/DESIGNED	CHECKED	APPROVED		G.TOL	TITLE	ROTARY DIP SWITCH		
H.S LEE	K.N KIM	W.J LEE		--				
2023-09-05	2023-09-05	2023-09-05	UNIT	SCALE	MODEL NO.	QDR-16H1	REV.	
邦斯达 BONSUDA Electronics 深圳市子庚科技有限公司				mm	N:S	DRAW NO.	QDR-16H1(LG)-01	01
				SIZE	A4			